

AFSCETAKBLI

SPECIFICATION SHEET
WWW.CONEN-SYSTEMS.COM

KEYBOARD SHELF FOR CCELW-AF AND SCETAVLI SERIES

FOR MOUNTING TO DISPLAY BRACKET

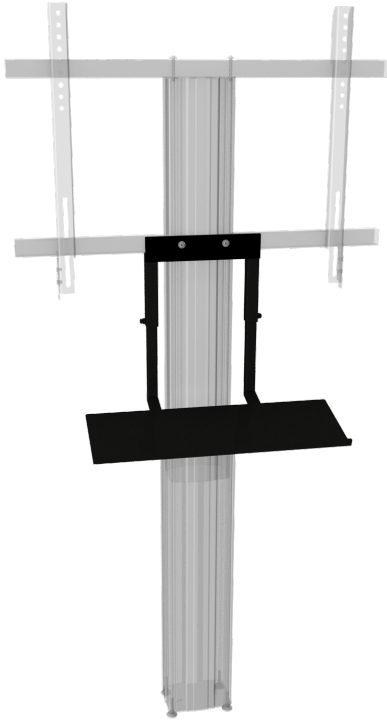

PRODUCT

Practical keyboard tray for attachment to the display mount CCELW-AF or SCETAVLI. This shelf for keyboards is black and ships including mounting hardware.

FEATURES

- Keyboard-shelf for mounting to the display mount
- Dimension: W/D: 600 x 200 mm
- Powder-coated steel, 2 mm, black (RAL 9005)
- Tube 30 x 30 mm/ 25 x 25 mm
- Includes mounting accessories (2x Allen head lens screws)



Display mount

Item number	AFSCETAKBLI	
Width / Height / Depth	600 mm / 374 mm - 500 mm / 344 mm	23.6" / 14.7" - 19.9" / 13.5"
Weight	4,4 kg	9.7 lbs
Packages	Package dimensions WxHxD	Package weight
AFSCETAKBLI	670 x 90 x 280 mm / 26.4 x 3.5 x 11"	5 kg / 11 lbs

Dimensions

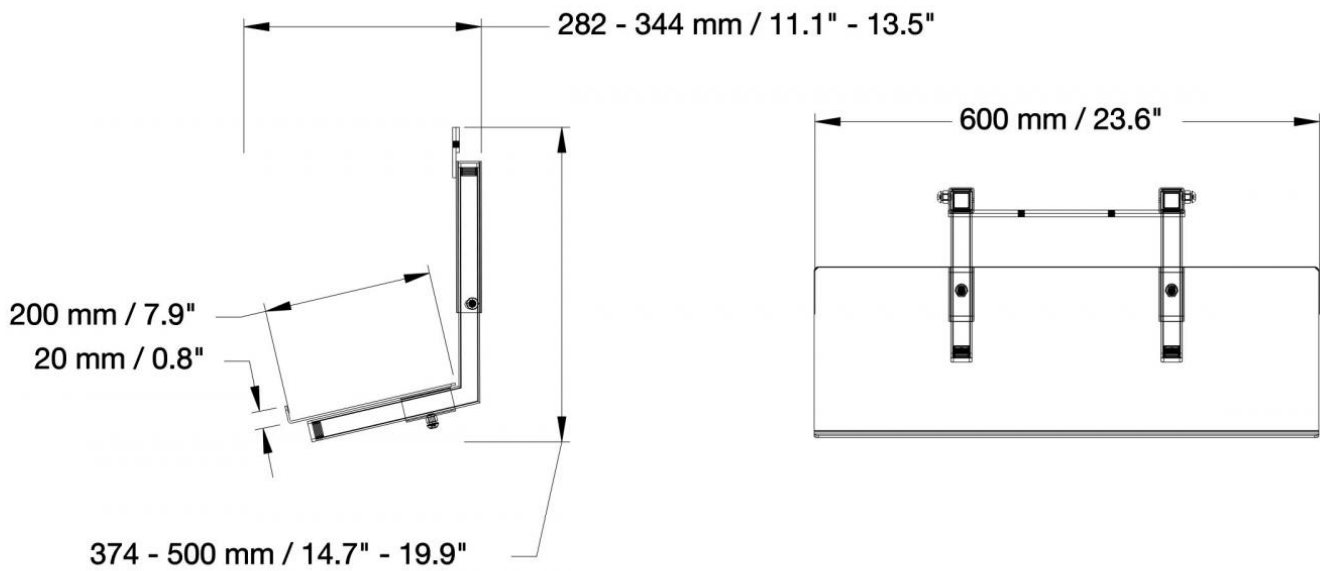

Conen Systems GmbH
 Conenstr. 4
 54497 Morbach-Gonzerath
 Germany

T +49 6533 75-100
 F +49 6533 75-600
 E service@conen-systems.com
www.conen-systems.com

© Copyright by Conen Systems GmbH

08/13/2024
 Page 2/2